

REV.	ECN NO.	DATE	SIGN	DESCRIPTION
A	Initial Release	2025/10/13	Ann	New Item

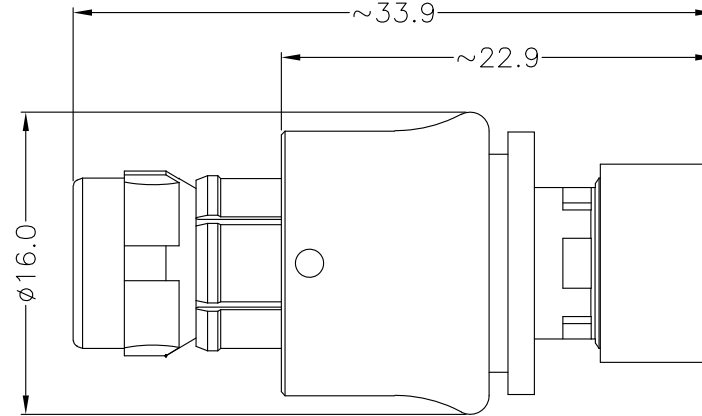

Part No.:
FSX1CXH-PXXMS-000

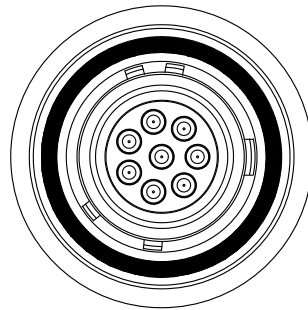

Note:

- * IP Grade: IP68(1.5M/24Hrs)
- * Insulation Material: PPS
- * Metal Shell Material: Aluminum
- * Surface Plated: Black Chrome

		All dimension in mm	
		TOLERANCE UNLESS OTHERWISE SPECIFIED ± 0.5	REV. A SCALE Free
DRAWN BY Ann	APPROVED BY Roy	DATE(Y/M/D) 2025/10/13	PAGE 1/1 SIZE A4
PART NO.: FSX1CXH-PXXMS-000		TITLE: FSX CABLE MOUNT PLUG	
CUSTOMER NO.:		THIS DOCUMENT IS CONFIDENTIAL AND A PROPERTY OF PRODACONN. DISCLOSURE TO THIRD PARTY HAS TO BE AUTHORIZED BY PRODACONN	

Pin Assignments(Connector Solder Cup View)

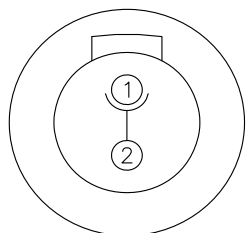

2Pin

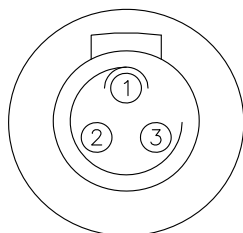

3Pin

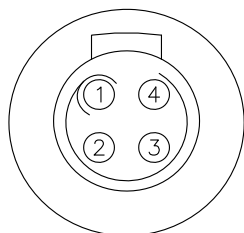

4Pin

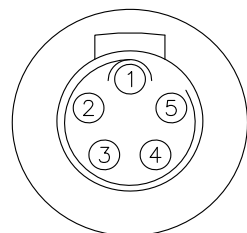

5Pin

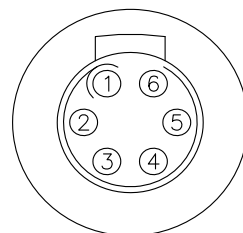

6Pin

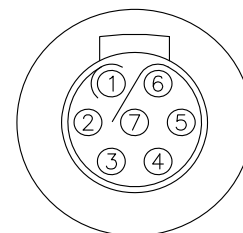

7Pin

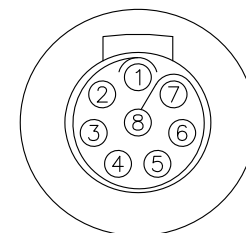

8Pin

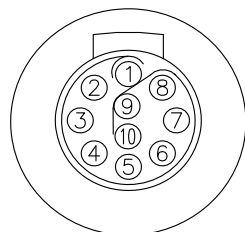

10Pin

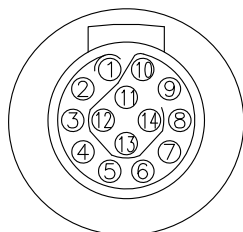

14Pin

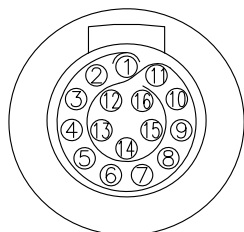

16Pin

Key Point

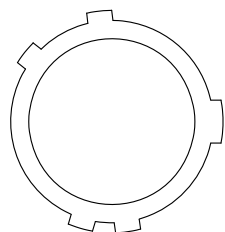

1(Light Brown)

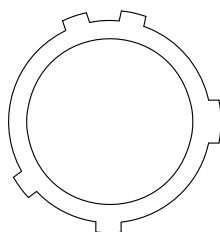

2(Red)

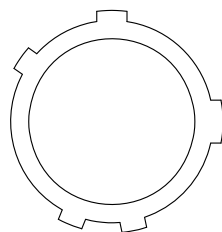

3(Blue)

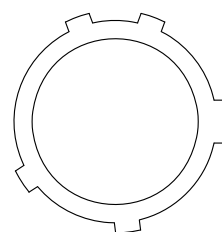

4(Green)

		All dimension in mm		
		TOLERANCE UNLESS OTHERWISE SPECIFIED ± 0.5	REV. A SCALE Free	
DRAWN BY Ann	APPROVED BY Roy	DATE(Y/M/D) 2025/10/13	PAGE 2/2	SIZE A4
PART NO: FSX1CXH-PXXMS-000		TITLE FSX CABLE MOUNT PLUG		
CUSTOMER NO:				
THIS DOCUMENT IS CONFIDENTIAL AND A PROPERTY OF PRODACONN. DISCLOSURE TO THIRD PARTY HAS TO BE AUTHORIZED BY PRODACONN				