

5	REV.	ECN NO.	DATE	SIGN	DESCRIPTION
01	Initial Release	2021/09/15	Ann	New Item	

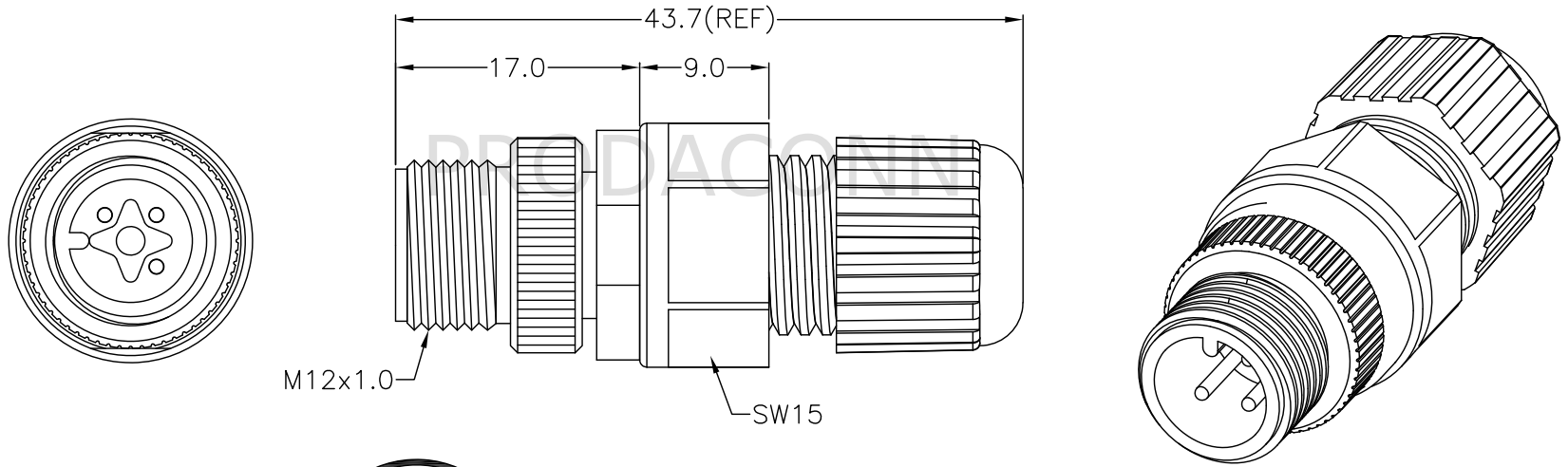

Note:
 * IP Grade: IP67
 * Rated current: 4A
 * Rated voltage: 250V AC/DC
 * Recommend Cable OD: 5.0~6.8mm

8	Sealing Nut	Nylon,Black	1
7	Seal	Silicone	1
6	Clamp Ring	Nylon,Black	1
5	Screw Nut	Aluminum Alloy,Nickel Plated	1
4	Shell	Copper Alloy,Nickel Plated	1
3	Gasket	Silicone	1
2	Pin	Copper Alloy,Gold Plated	3
1	Housing	PBT,Black	1
NO.	ITEM	SPEC	QTY

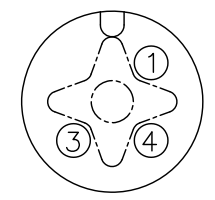

Pin Assignments
Front View

		All dimension in mm	
		TOLERANCE UNLESS OTHERWISE SPECIFIED ± 0.5	REV. 01 SCALE 1:1
DRAWN BY Ann	APPROVED BY Roy	DATE(Y/M/D) 2021/09/15	PAGE 1/1 SIZE A4
PART NO: 12A03-PASH-LS0-F0		TITLE: M12,A-CODE,ASS'Y	
CUSTOMER NO:		THIS DOCUMENT IS CONFIDENTIAL AND A PROPERTY OF TiMyn. DISCLOSURE TO THIRD PARTY HAS TO BE AUTHORIZED BY Prodaconn.	

BOM LIST